



SAFETY SMART - EcoMAXX™ NO RETURN EXPLOSION ISOLATION VALVES SATISFY CURRENT 2014 NFPA REQUIREMENTS!

The Installation of an Explosion Isolation Device on all suction side ducts that transport material with a Kst value above zero is a NFPA Requirement.



Installing a **SAFETY SMART** EcoMAXX™ No Return Valve (EM-NRV) will protect workers and facilities from the damaging effect of a baghouse or filter explosion.

EcoMAXX™ No Return Valves are an integral component that is recommended for use with EcoBoss™ Energy Management Systems, EcoMAXX™ Fire Break Shutters, and EcoMAXX™ Fire Suppression Systems.

Standard Features

- Heavy Duty Welded Steel Construction
- Flanged Inlet and Outlet with Co-Flanges
- Inspection/Access Door
- Grounding Lug
- Locking Mechanism
- ATEX Certified

The EM-NRV is 100% NFPA 69-2014 compliant with the following optional features:

-  • **O-EM-NRV-MS** - Micro-switch for system shut down
-  • **O-EM-NRV-DLS** - Dust Level Sensor
-  • **O-EM-NRV-CP** - Control panel for sensor power and integration with existing, new or EcoBOSS™ Control Panel



EcoMAXX™ No Return Explosion Isolation Valve installed with EcoMAXX™ Firebreak Shutter.

certified: ATEX EN15089 & EN16447 

NO RETURN VALVE (NRV) DIMENSIONS (sizes 7" - 28")

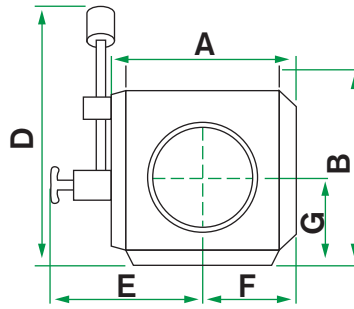
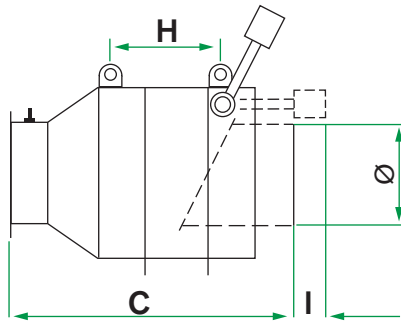

RATED FOR:

Class ST 3 Applications
Kst max 400 bar m/s
P_{red} 0.50 bar

*NOTE: Co-flanges provided to slip over imperial sized ductwork.

Model #	Ø	A	B	C	D	E	F	G	H	I	LBS
EM-NRV07	7.09"/180mm	14.1	13.3	21.6	13.3	11.8	7	6.6	-	-	45
EM-NRV08	7.87"/200mm	14.1	13.3	21.6	13.3	11.8	7	6.6	-	-	45
EM-NRV10	9.84"/250mm	16.1	15.3	23.6	15.3	12.7	8	7.6	-	-	56
EM-NRV12	11.81"/300mm	18.1	17.3	26.3	23.6	13.7	9	8.6	-	4.5	84
EM-NRV14	13.78"/350mm	20	19.2	28.3	25.5	14.7	10	9.6	-	4.5	100
EM-NRV16	15.75"/400mm	22	23.2	30.3	29.5	15.7	11	10.6	13.7	6.4	120
EM-NRV18	17.72"/450mm	24	25.1	32.2	33.2	16.7	12	11.6	15.7	8.4	150
EM-NRV20	19.69"/500mm	25.9	27.1	34.2	38.7	17.7	12.9	12.5	18.1	12.4	177
EM-NRV22	21.65"/550mm	27.9	29.1	36.2	37.4	18.7	13.9	13.5	19.6	8.4	221
EM-NRV24	23.62"/600mm	29.9	31.1	38.1	41.1	19.6	14.9	14.5	21.6	10.4	254
EM-NRV26	25.59"/650mm	31.8	33	40.1	45	20.6	15.9	15.5	23.8	12.4	276
EM-NRV28	27.56"/700mm	33.8	35	42.1	47	21.6	16.9	16.5	25.5	12.4	298

NO RETURN VALVE (NRV) DIMENSIONS (sizes 32" - 40")

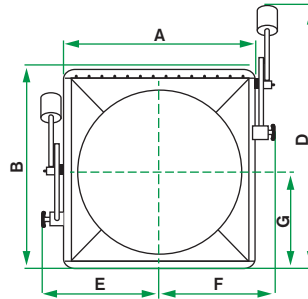
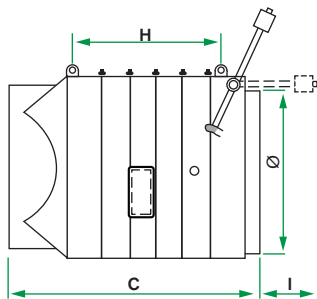

RATED FOR:

Class ST 2 Applications
Kst max 299 bar m/s
P_{red} 0.25 bar

*NOTE: Co-flanges provided to slip over imperial sized ductwork.

Model #	Ø	A	B	C	D	E	F	G	H	I	LBS
EM-NRV32	31.49"/800mm	38.5	40.1	52.3	56.4	25.9	25.9	18.8	28.1	14.1	728
EM-NRV36	35.43"/900mm	42.5	44.5	56.2	60.4	27.9	27.9	20.8	27.9	14.1	860
EM-NRV40	39.37"/1000mm	46.4	48	60.2	64.3	29.9	29.9	22.8	35.8	14.1	999

44" & 48" are available! Contact Boss Products for more details.

DISTRIBUTED BY:

© BossProducts - 3.2016



PO Box 953
33100 NE Ivy Ave
La Center, WA 98629
360-263-2360
360-263-9772 (fax)
bossproductsamerica.com

